

Article number: 03505012

Description: Fluro Rod end GE 12FO

Measures

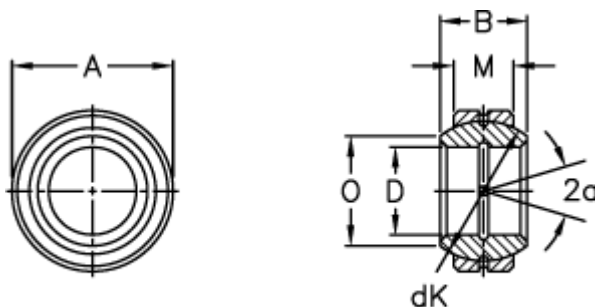

Str. 6–12 uden smørerille

A	= 26 0 -0,009	Tilt angle = 18
B	= 15	Weight = 34
D	= 12 0 -0,008	
dK	= 22	
Dynamic load C (kN)	= 17	
M	= 9	
O	= 16	
Static load C0 (kN)	= 85	